

# PGS S36T Grill Spec Sheet

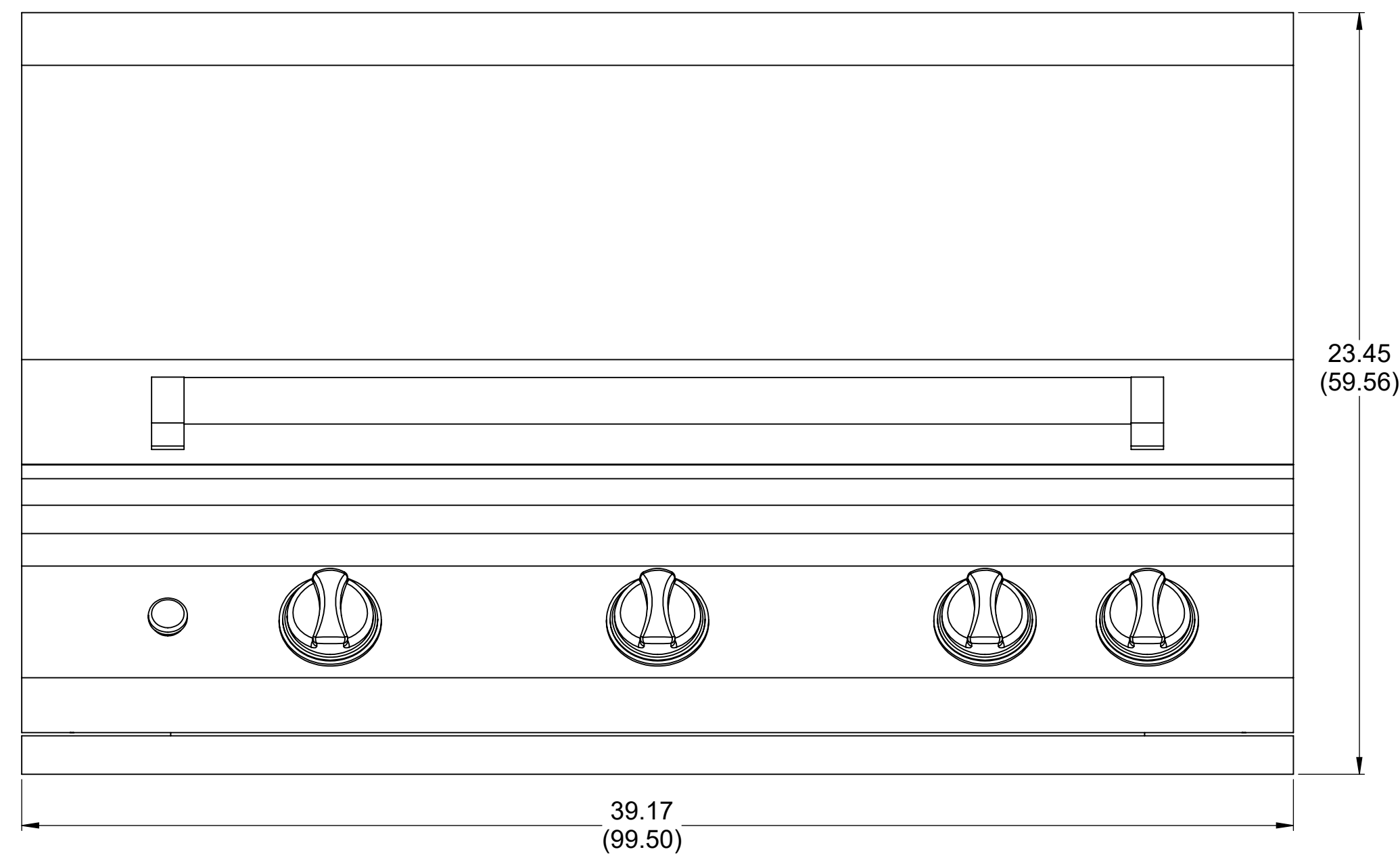

TOP VIEW



FRONT VIEW

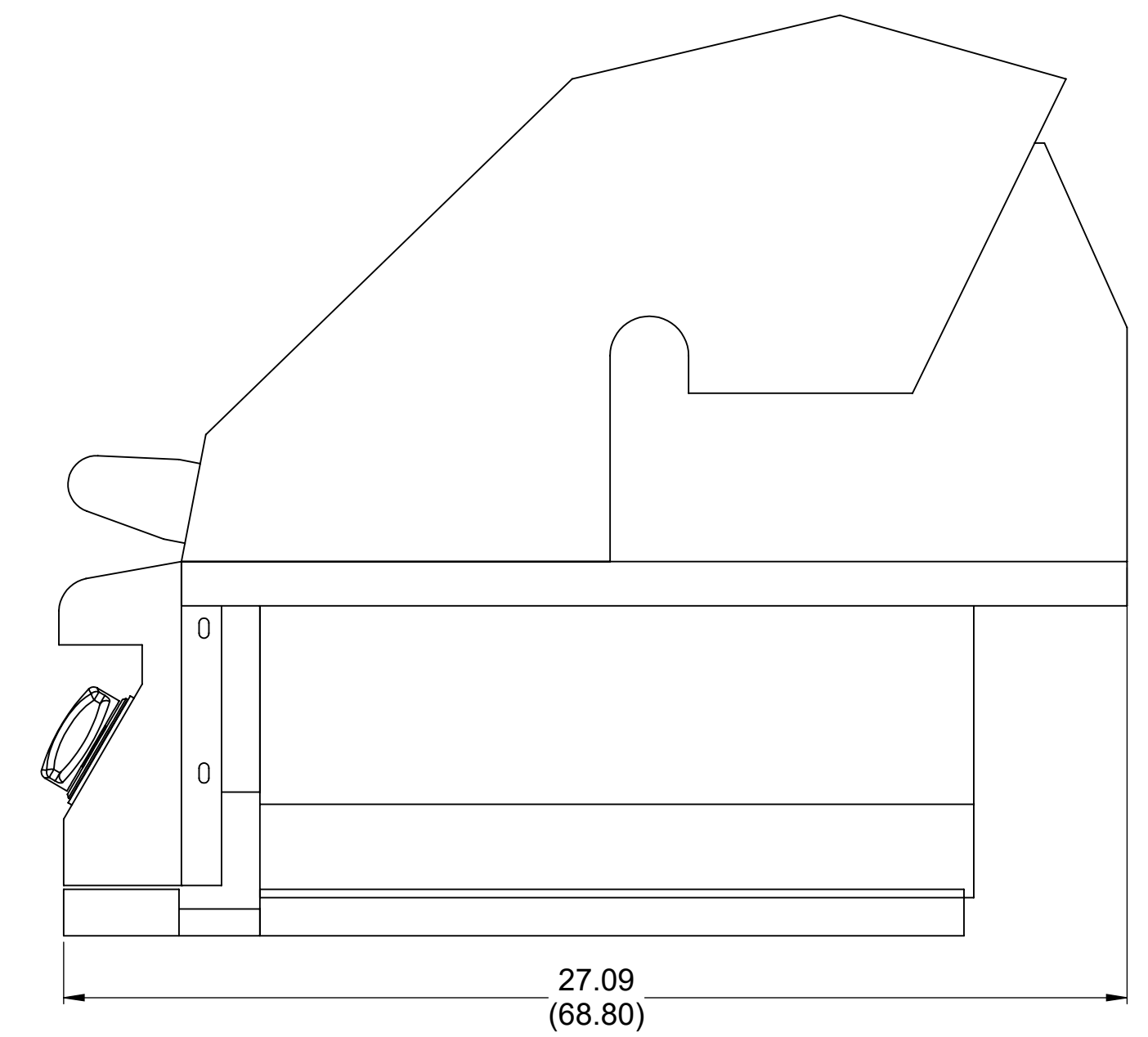

SIDE VIEW

ITEM	WIDTH (W)	DEPTH (D)	HEIGHT (H)
S27T, E27T & LBC	28"	23"	9-1/2"
S36T	36-1/2"	23"	9-1/2"
S48T	49"	23"	9-1/2"
SIDE BURNER / SMALL BEV	12-1/2"	18-1/2"	9"
M2DS	14"	2-1/4"	20"
MDS L20	19-1/2"	2-1/4"	12-1/2"
MDS L30	29-1/4"	2-1/4"	19-3/8"
MDS L39	38"	2-1/4"	19-3/8"

\*\*\* ALL MEASUREMENTS ARE BASED ON 34" MINIMUM COUNTER HEIGHT AND A 6" TO 12" BACKSPASH.  
 \*\*\* ISLAND MUST BE VENTED! CHECK LOCAL BUILDING AND FIRE CODES PRIOR TO INSTALLATION.

RECOMMEND TO BUILD WITH NON-COMBUSTIBLE MATERIALS

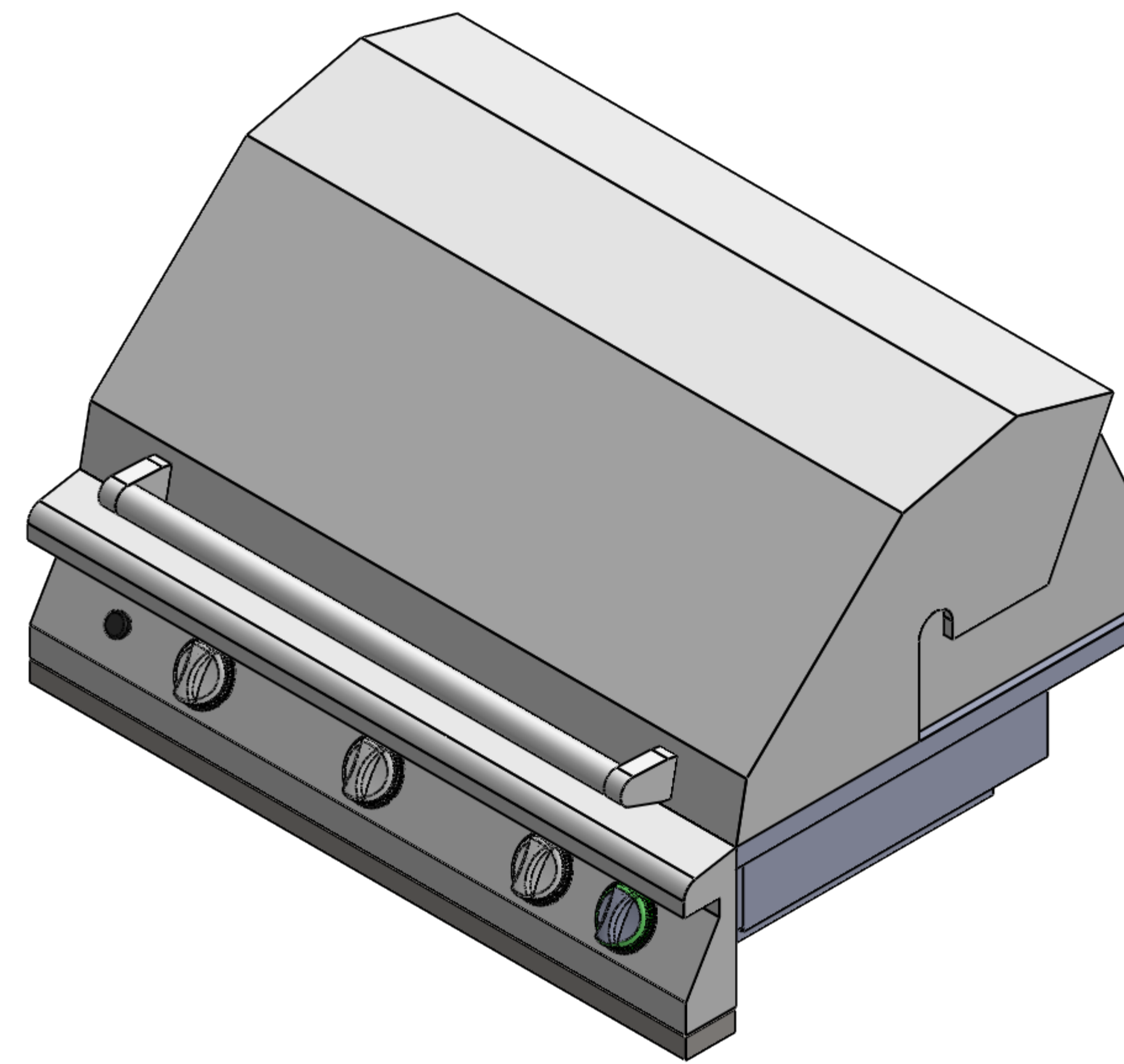
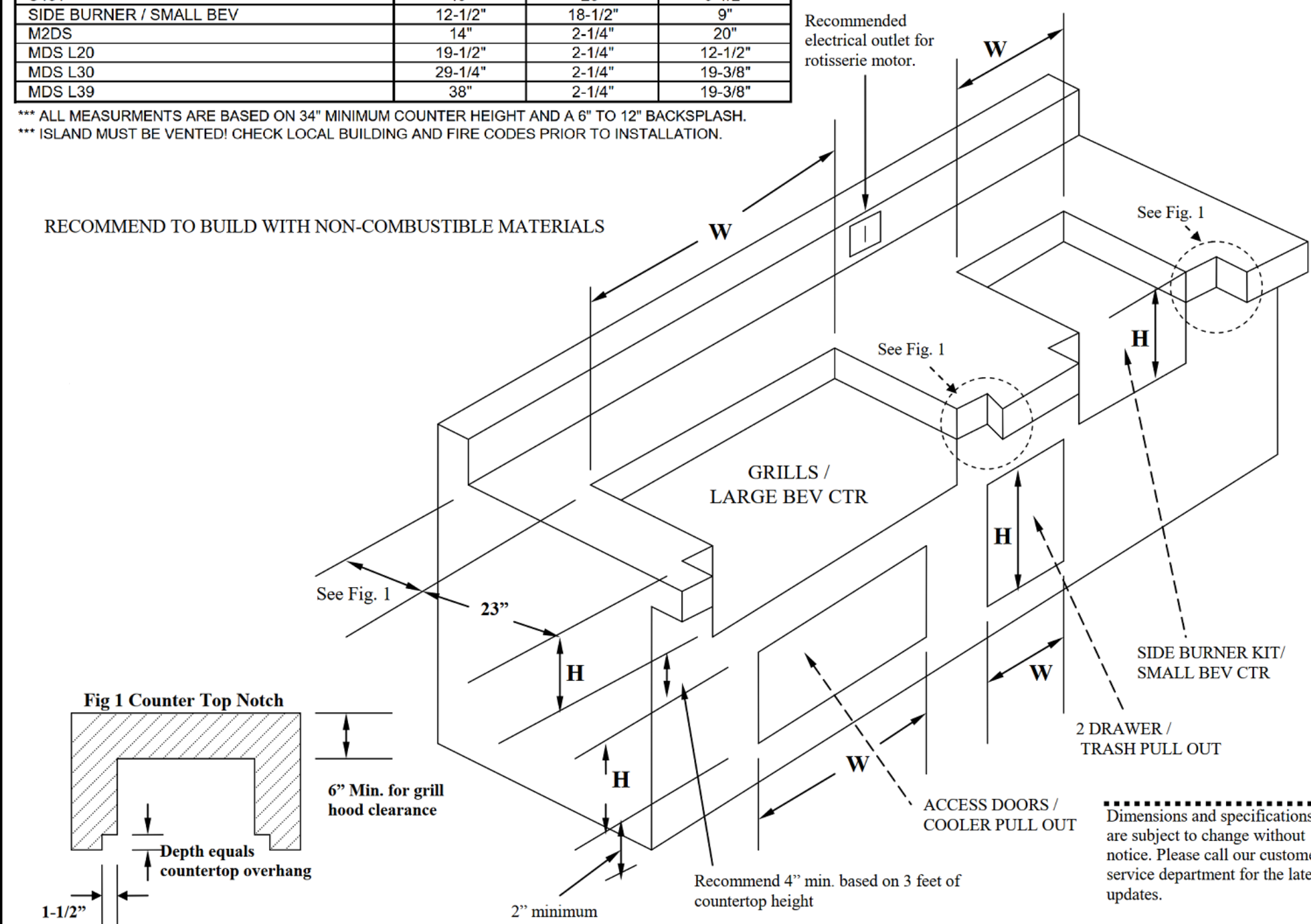

TITLE: **S36T**